

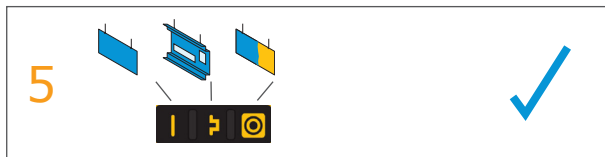

# Short Operating Manual Kurzanleitung

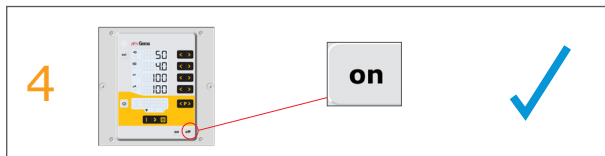

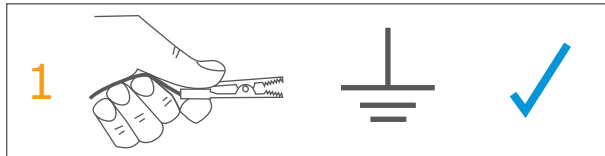
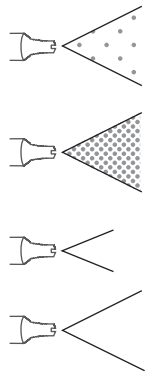

on/off

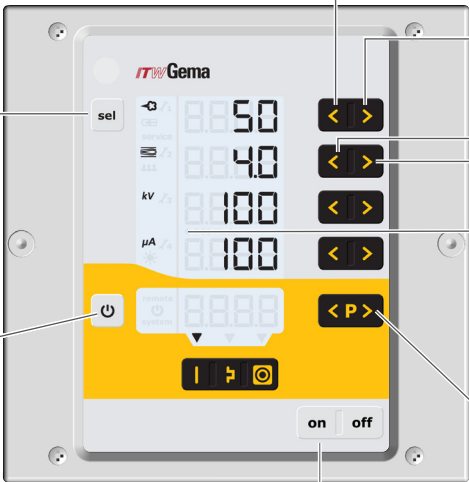
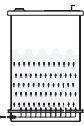

Program 01-20  
0-100 kV  
0-100 µA



SuperCorona



PowerClean  
with 30 Nm<sup>3</sup>/h

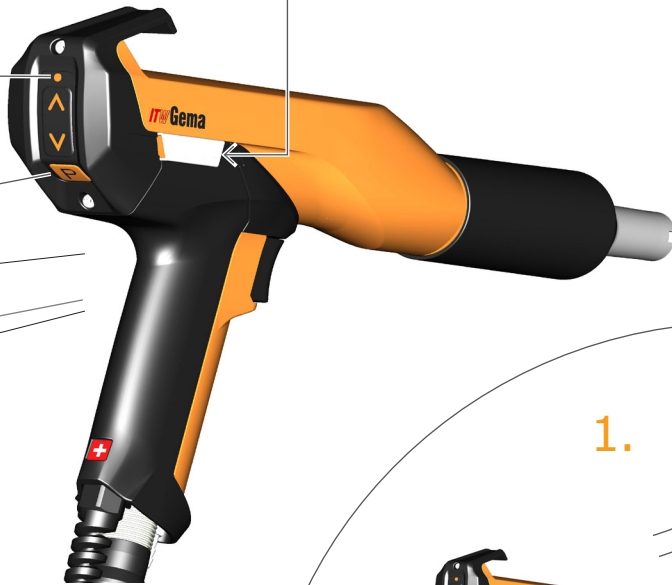
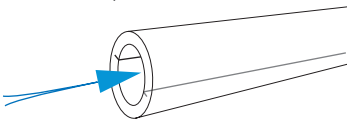

1.



2.



**1 x**

= Automatic Procedure

**2 x**

= Manual Procedure

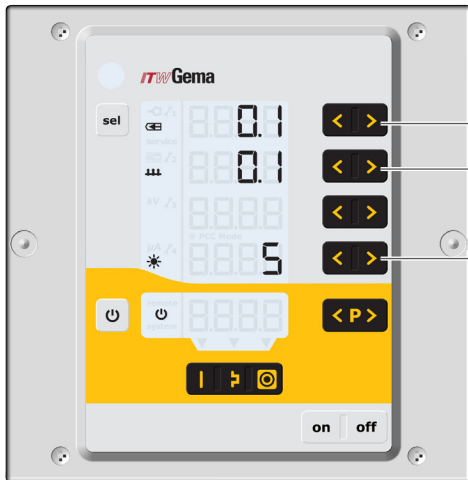

~ 0.1 Nm<sup>3</sup>/h

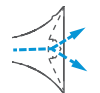

~ 0.5 Nm<sup>3</sup>/h

0.1 - 1.0 Nm<sup>3</sup>/h

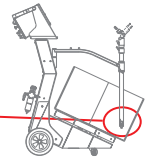
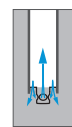

0.0-5.0 Nm<sup>3</sup>/h

